

5

4

3

2

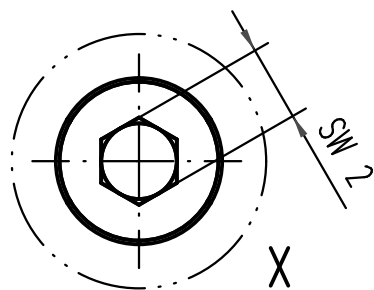
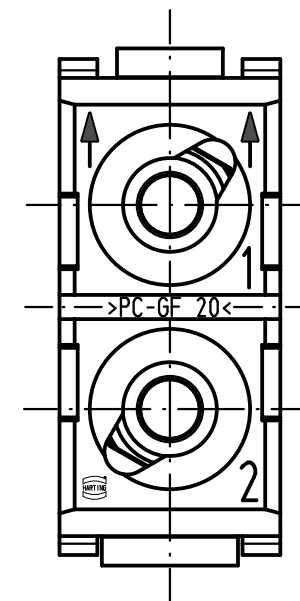
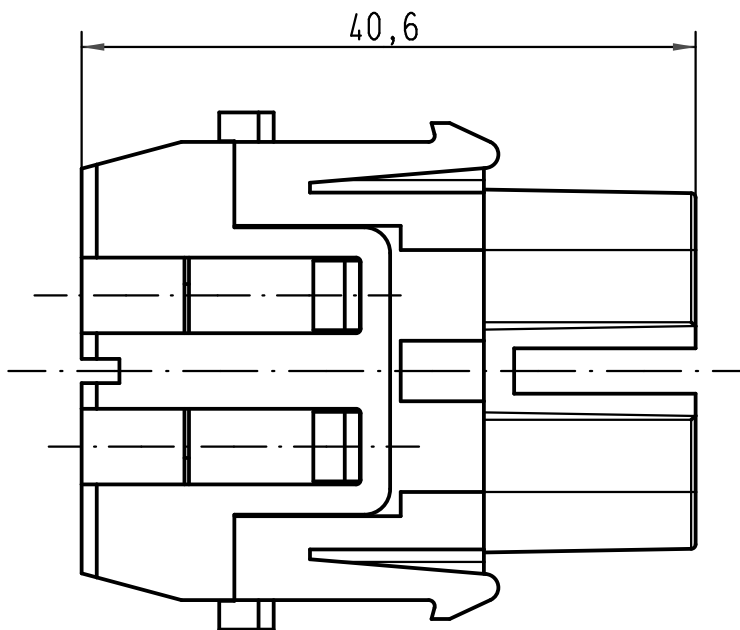
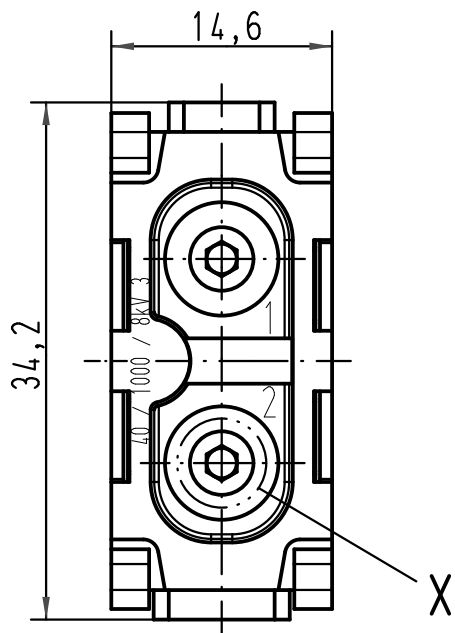

1

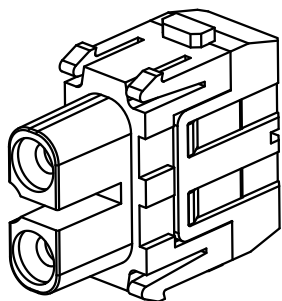

X
5:1

für Litze 2,5-8mm²/
for stranded wire 2,5-8mm²



 All Dimensions in mm Original Size DIN A 4			Techn. Character.			Nicht tolerierte Masse/ Free size tolerances	
				Dat.	Name	Maßstab/ Scale 2:1 5:1	Han-Axialschraub-Modul/ Han axial screw-module Buchseneinsatz (F) / female insert (F)
			Detail.	16.05.97	ML		
412850	05.04.07	ML	Insp.		HERB.		
412531	09.11.06	ML	Stand.				
25600	29.03.99	KR					
22422	29.10.97	ML					
Mod.	Dat.	Name	HARTING Electric GmbH & Co.KG D-32339 Espelkamp				TB 09 14 002 2701
							Sub.

D

C

B

A